

IBK

FM 300 – Serie – Elektronikgehäuse
4 Teilungseinheiten nach DIN 43880:1988 – 12 (á 18 mm)
72 mm breit

Elektronikgehäuse mit Klappdeckel FM 350

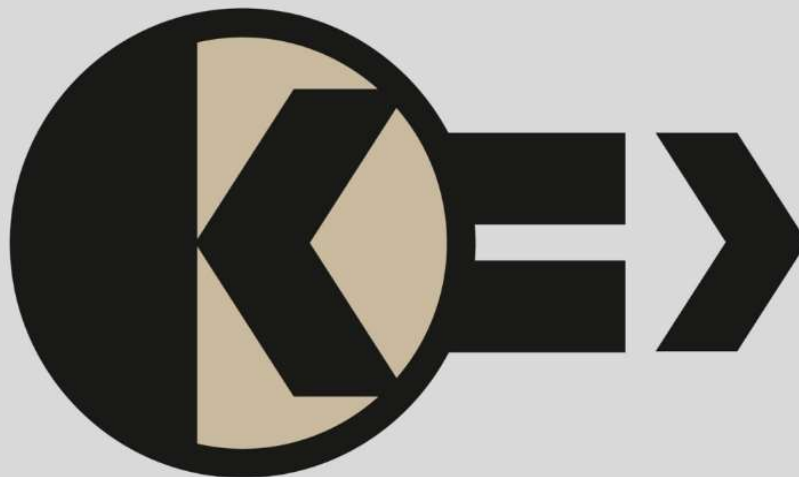

INDUSTRIEBERATUNG
KRÜGER
technology for the future

Elektronikgehäuse mit Klappdeckel FM 350

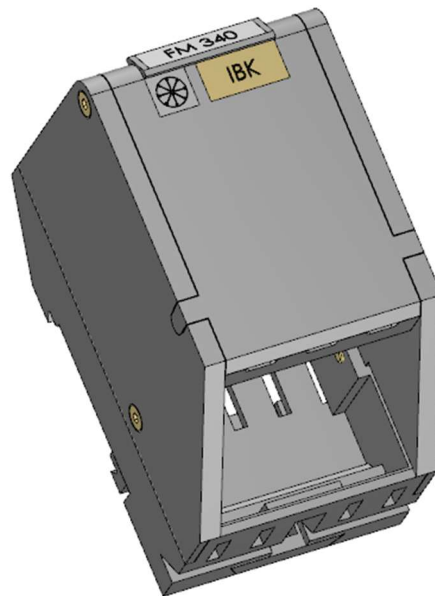

Elektronikgehäuse mit Klappdeckel FM 350

Das Modul FM 350 ist ein fingersicheres Gehäuse für elektronische Platinen, welche in ein 72 mm breites Gehäuse passen. Es hat einen Klappdeckel, wodurch beim Öffnen dieses Klappdeckels eine möglicherweise vorhandene Platine mit Justagemöglichkeiten diese Justierungen umstandslos zulassen.

